











82 444 970



- saillie 124 mm
- volume de bouteille de 500 ml
- à remplir par le haut
- tête du distributeur orientable
- hauteur 124 mm
- rosace Ø 55 mm
- diamètre de percement 25 mm

S'adapte aux gammes suivantes: ELIO, ENO, MEM, META SQUARE, SYNC, TARA et TARA ULTRA

S'adapte aux gammes suivantes : ELIO, MEM, TARA, TARA ULTRA, META SQUARE

	Chrome	82 444 970-00
	Platine brossé	82 444 970-06
	Platine	82 444 970-08
	Laiton (Or 23cts)	82 444 970-09
	Dark Chrome	82 444 970-19
	Laiton brossé (Or 23cts)	82 444 970-28
	Noir mat	82 444 970-33
	Champagne brossé (Or 22cts)	82 444 970-46
	Champagne (Or 22cts)	82 444 970-47
	Chrome brossé	82 444 970-93
	Dark Platinum brossé	82 444 970-99

82 444 970

mm [inches]

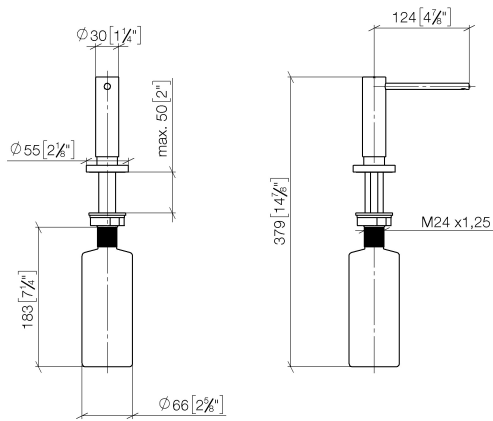

82 444 970

Les pièces pour les autres finitions peuvent être trouvées ici : Platine brossé



### Liste des pièces de rechange

N°	Article Numéro	Désignation	Fréquence de montage	Délai de livraison
1	90 10 10 538 00-00	distributeur	1	10
2	90 27 97 506 00-00	rosace	1	10
3	09 14 10 151 90	joint	1	2
4	08 10 10 527 90	patte de fixation	1	2
5	05 23 10 001 00 90	set de fixation	1	2
6	90 10 10 603 00 90	réceptif	1	2